



FINALLY, YOUR CHARGER GETS ITS OWN APP!



Made for
iPod iPhone

Available on the
App Store

ANDROID APP ON
Google play

6X80+
Blue Version



Manufactured by
SKYRC TECHNOLOGY CO., LTD.
www.skyrc.com

All specifications and figures are subject to change without notice.
Printed in China ©2013 7504-0341-02



10 80Watt
AMP

AC/DC
FAST CHARGER

Bluetooth

INTRODUCTION..... 01

SPECIAL FEATURES.....03

WARNING AND SAFETY NOTES.....06

LITHIUM BATTERY CONNECTION DIAGRAM..... 10

PROGRAM FLOW CHART..... 12

OPERATION..... 14

LITHIUM BATTERY(LiPo/LiFe/Lilon)PROGRAM..... 15

 Charging Lithium Battery at Balance Mode.....15

 Charging of Lithium Battery..... 16

 'FAST' Charging of Lithium Battery..... 17

 'STORAGE' Control of Lithium Battery..... 18

Discharging Lithium Battery..... 19

NIMH/NICD BATTERY PROGRAM..... 20

 Charging of NiMH/NiCd Battery..... 20

 Charging NiMH/NiCd Battery in The AUTO Charge Mode..... 20

 Discharging of NiMH/NiCd Battery..... 21

 Charging NiMH/NiCd Battery In Re-Peak Charge Mode..... 21

 Charge/Discharge & Discharge/Charge Cycle of NiMH/NiCd Battery..... 22

Pb(lead-sulphuric acid) battery program..... 23

 Charging of Pb Battery..... 23

 Discharging of Pb Battery..... 23

USING THE CHARGE CONTROL SOFTWARE "CHARGE MASTER"..... 24

BATTERY MEMORY SET..... 25

LITHIUM BATTERY METER..... 27

MOTOR RPM TESTER..... 28

SERVO TESTER..... 29

SYSTEM SET UP..... 30

VARIOUS INFORMATION DURING THE PROCESS..... 32

WARNING AND ERROR MESSAGE..... 33

PAIRING CHARGER WITH SMART PHONE..... 34

SPECIFICATION..... 36

RECOMMENDED ACCESSORIES..... 37

LIABILITY EXCLUSION..... 38

CONFORMITY DECLARATION..... 38

WARRANTY AND SERVICE..... 39

Congratulations on your choice of the SKYRC 6x80 Plus digital intelligent charger from SKYRC Technology Co., Ltd.

The unit is simple to use, but the operation of a sophisticated automatic charger such as SKYRC 6x80 Plus does require some knowledge on the part of the user. These operating instructions are designed to ensure that you quickly become familiar with its functions. It is therefore important that you read right through the Operating Instructions, Warning and Safety Notes before you attempt to use your new automatic charger for the first time. We hope you have many years of pleasure and success with your new battery charger.

SKYRC 6x80 Plus is a high-performance, micro processor control charge/discharge station with battery management suitable for use with all current battery types. With integral equalizer for six-cell, Lithium-Polymer (LiPo), Lithium-Ferrum (LiFe) and Lithium-Ion (Lilon) batteries. Maximum 10A charge current; maximum 80W charge power; can be powered by a 12 Volt car battery or from 100V-240V via the built in switch-mode power supply.

When a Nickel battery is fully charged, the unit terminates the process using the Delta-Peak method. Lithium and lead (Pb) batteries are charged using the CC-CV method.

The fan cooling system is so smart and efficient. The fan speed is controlled by internal temperature sensor.

It also adds lithium Batt Meter, Motor RPM Tester and Servo Tester functions. It is convenient for user to get some useful information with this charger.

Finally, your charger gets its own apps. This charger can be controlled and operated by smart phones.

It can be dangerous to mis-handle batteries and battery chargers, as there is always a risk of batteries catching fire and exploding.

Please BE SURE to read these INSTRUCTIONS, WARNING and SAFETY NOTES before you use the charger for the first time.

Please read this entire operating manual completely and attentively before using this product, as it covers a wide range of information on operating and safety. Or please do use this product in company with a specialist!

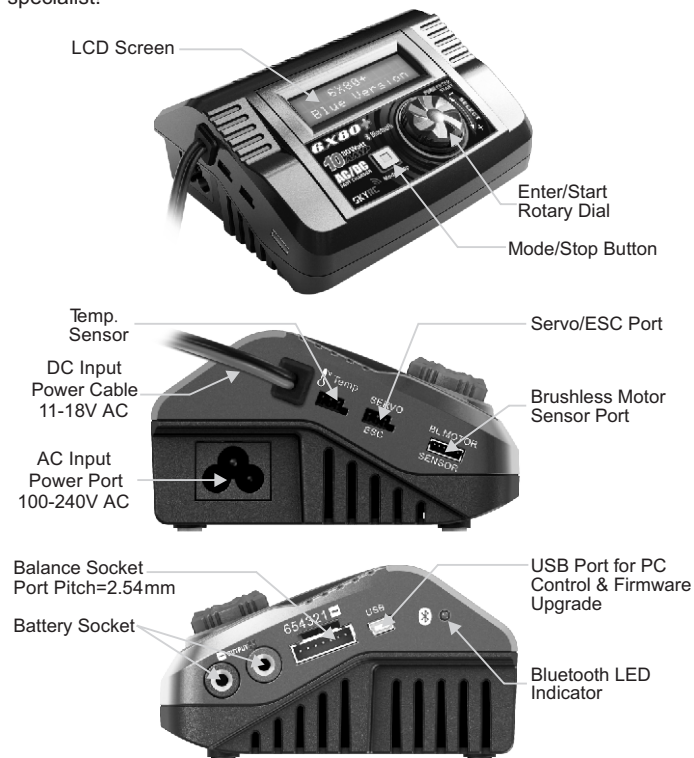

Optimized Operating Software

SKYRC 6x80 Plus features the so-called AUTO function that set the feeding current during the process of charging or discharging. Especially for lithium batteries, it can prevent the overcharging which may lead to an explosion due to the user's fault. It can disconnect the circuit automatically and alarm once detecting any malfunction. All the programs of this product were controlled through two way linkage and communication, to achieve the maximum safety and minimize the trouble. All the settings can be configured by users!

Internal Independent Lithium Battery Balancer

SKYRC 6x80 Plus employs an individual-cell-voltage balancer. It isn't necessary to connect an external balancer for balance charging.

Balancing Individual Cells Battery Discharging

During the process of discharging, SKYRC 6x80 Plus can monitor and balance each cell of the battery individually. Error message will be indicated and the process will be ended automatically if the voltage of any single one cell is abnormal.

Adaptable to Various Type of Lithium Battery

SKYRC 6x80 Plus is adaptable to various types of lithium batteries, such as LiPo, Lilon and the new LiFe series of batteries.

Fast and Storage Mode of Lithium Battery

Purposes to charge lithium battery varies, 'fast' charge reduce the duration of charging, whereas 'store' state can control the final voltage of your battery, so as to store for a long time and protect useful time of the battery.

Cyclic Charging/Discharging

1 to 5 cyclic and continuous process of charge>discharge or discharge > charge is operable for battery refreshing and balancing to stimulate the battery's activity.

Data Store/Load

The charger can store up to 10 different charge/discharge profiles for your convenience. You can keep the data pertaining to program setting of the battery of continuous charging or discharging. Users can call out these data at any time without any special program setting.

Terminal Voltage Control(TVC)

The charger allows user to change the end voltage.

Lipo Battery Meter

The user can check battery's total voltage, the highest voltage, the lowest voltage and each cell's voltage.

Motor RPM Tester

Users connect the sensor motor and charger with sensor wire, set the pulse width and test the RPM of the motor.

Servo Tester

Connect the servo and the charger with wire, change the pulse width value and check whether the servo works or not.

Re-Peak Mode of NiMH/NiCd Battery

In re-peak charge mode, the charger can peak charge the battery once, twice or three times in a row automatically. This is good for making certain the battery is fully charged, and for checking how well the battery receives fast charges.

Delta-peak Sensitivity for NiMH/NiCd

Delta-peak sensitivity for NiMH/NiCd battery: The automatic charge termination program based on the principle of the Delta-peak voltage detection. When the battery's voltage exceeds the threshold, the process will be terminated automatically.

Automatic Charging Current Limit

You can set up the upper limit of the charging current when charging your NiMH or NiCd battery, it is useful for the NiMH battery of low impedance and capacity in the 'AUTO' charging mode.

Capacity Limit

The charging capacity is always calculated as the charging current multiplied by time. If the charging capacity exceeds the limit, the process will be terminated automatically when you set the maximum value.

Temperature Threshold*

The battery's internal chemical reaction will cause the temperature of the battery to rise. If the temperature limit is reached, the process will be terminated.

** This function is available by connecting optional temperature probe, which is not included in the package.*

Processing Time Limit:

You can also limit the maximum process time to avoid any possible defect.

PC Control Software "Charge Master"

The free "Charge Master" software gives you unparalleled ability to operate the charger through the computer. You can monitor pack voltage, cell voltage and other data during the charging, view charge date in real-time graphs. And you can initiate, control charging and update firmware from "Charge Master".

APPS for Smart Phone (both iOS and Android)

Finally, your charger gets its own apps. This charger can be controlled and operated by smart phones.

These warnings and safety notes are particularly important. Please follow the instructions for maximum safety; otherwise the charger and the battery can be damaged or at worst it can cause a fire.

- ❗ Never leave the charger unattended when it is connected to its power supply. If any malfunction is found, TERMINATE THE PROCESS AT ONCE and refer to the operation manual.
- ❗ Keep the charger well away from dust, damp, rain, heat, direct sunshine and vibration. Never drop it.
- ❗ The allowable DC input voltage is 11-18V DC.
- ❗ The allowable AC input voltage is 100-240V AC.
- ❗ This charger and the battery should be put on a heat-resistant, non-flammable and non-conductive surface. Never place them on a car seat, carpet or similar surface. Keep all flammable volatile materials away from the operating area.
- ❗ Make sure you know the specifications of the battery to be charged or discharged to ensure it meets the requirements of this charger. If the program is set up incorrectly, the battery and charger may be damaged. Fire or explosion can occur due to overcharging. This warranty is not valid for any damage or subsequent damage arising as a result of a misuse or failure to observe the procedures outlined in this manual.
- ❗ To avoid short circuiting between the charge lead, always connect the charge cable to the charger first, then connect the battery. Reverse the sequence when disconnecting.
- ❗ Never attempt to charge or discharge the following types of batteries:
 - A battery pack which consists of different types of cells (including different manufacturers)
 - A battery that is already fully charged or just slightly discharged
 - Non-rechargeable batteries (pose an explosion hazard)
 - A faulty or damaged battery
 - A battery fitted with an integral charge circuit or a protection circuit

- Batteries installed in a device or which are electrically linked to other components
- Batteries that are not expressly stated by the manufacturer to be suitable for the currents the charger delivers during the charge process

❗ **Please bear in mind the following points before commencing charging:**

- Did you select the appropriate program suitable for the type of battery you are charging?
- Did you set up adequate current for charging or discharging?
- Have you checked the battery voltage? Lithium battery packs can be wired in parallel and in series, i.e. a 2-cell pack can be 3.7V (in parallel) or 7.4V (in series).
- Have you checked that all connections are firm and secure? Make sure there are no intermittent contacts at any point in the circuit.

Standard Battery Parameters

	LiPo	LiIon	LiFe	NiCd	MiMH	Pb
Nominal Voltage	3.7V/cell	3.6V/cell	3.3V/cell	1.2V/cell	1.2V/cell	2.0V/cell
Max Charge Voltage	4.2V/cell	4.1V/cell	3.6V/cell	1.5V/cell	1.5V/cell	2.46V/cell
Storage Voltage	3.8V/cell	3.7V/cell	3.3V/cell	n/a	n/a	n/a
Allowable Fast Charge	≤1C	≤1C	≤4C	1C-2C	1C-2C	≤0.4C
Min. Discharge Voltage	3.0-3.3V/cell	2.9-3.2V/cell	2.6-2.9V/cell	0.1-1.1V/cell	0.1-1.1V/cell	1.8V/cell

Be very careful to choose the correct voltage for different types of battery otherwise you may cause damage to the batteries. Incorrect settings could cause the cells to fire or explode.

⚠ Charging

During charge process, a specific quantity of electrical energy is fed into the battery. The charge quantity is calculated by multiplying charge current by charge time. The maximum permissible charge current varies depending on the battery type or its performance, and can be found in the information by the battery manufacturer. Only batteries that are expressly stated to be capable of quick-charge are allowed to be charged at rates higher than the standard charge current.

Connect the battery to the terminal of the charger: red is positive and black is negative. Due to the difference between resistance of cable and connector, the charger can not detect resistance of the battery pack, the essential requirement for the charger to work properly is that the charge lead should be of adequate conductor cross-section, and high quality connectors which are normally gold-plated should be fitted to both ends.

Always refer to the manual by the battery manufacturer pertaining to charging methods. Operate according to their recommended charging current and charging time. lithium batteries, in particular, should be charged strictly according to the manufacturer's instruction.

Close attention should be paid to the connection of lithium batteries.

Do not attempt to disassemble the battery pack arbitrarily.

Please get highlighted that lithium battery packs can be wired in parallel and in series. In the parallel connection, the battery's capacity is calculated by multiplying single the battery's capacity by the number of cells, bearing in mind that total voltage stays the same. If the voltage is imbalanced, it may cause a fire or explosion. Lithium batteries are recommended to charge in series.

⚠ Discharging

The main purpose of discharging is to clean the residual capacity of the battery, or to reduce the battery' voltage to a defined level. The same attention should be paid to the discharging process as the charging process. The final discharge voltage should be set up correctly to avoid deep discharging. Lithium batteries cannot be discharged to lower than the minimum voltage, or it will cause a rapid loss of capacity or a total failure. Generally, lithium batteries don't need to be discharged. Please pay attention to the minimum voltage of lithium batteries to protect them.

Some rechargeable batteries have a memory effect. If they are partly used and recharged before the whole charge is accomplished, they remember this and will only use that part of their capacity next time. This is a 'memory effect' It is said that NiMH and NiCd batteries are suffering from memory effect. NiCd has more 'memory effect' than NiMH.

Lithium batteries are recommended to be discharged partially rather than fully. Frequent full discharging should be avoided if possible. Instead, charge the battery more often or use a battery of larger capacity. Full capacity cannot be reached until it has been subjected to 10 or more charge cycles. The cyclic process of charge and discharge will optimize the capacity of battery pack.

SKYRC 6x80 Plus comes with the built in switching power supply. You can connect the AC power cord directly to the main AC socket. (100-240V AC). For attaching directly to 12V car batteries. It is critically important that you use a fully charged 13.8V car battery.

NOTE: DC INPUT: The maximum charge circuit power is 80W.
AC INPUT: The maximum charge circuit power is 50W.



Using terminal clip attaching to car battery

CONNECTING THE BATTERY

Important!!! Before connecting a battery it is absolutely essential to check one last time that you have set the parameters correctly. If the settings are incorrect, the battery may be damaged, and could even burst into flames or explode. To avoid short circuits between the banana plugs, always connect the charge leads to the charger first, and only then to the battery. Reverse the sequence when disconnecting the pack.

Balance socket:

The balance wire attached to the battery must be connected to the charger with the black wire aligned with the negative marking. Take care to maintain correct polarity! (See the wiring diagram below.)

This diagram shows the correct way to connect your battery to the SKYRC 6x80 Plus while charging in the balance charge program mode only.

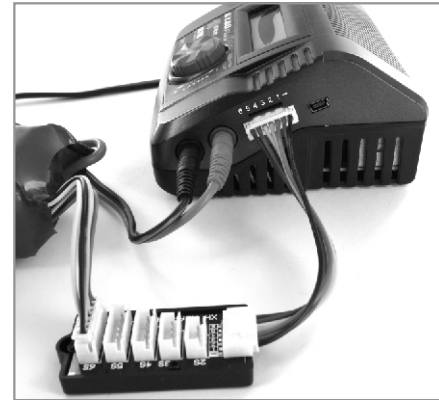

WARNING:

⚠ Failure to connect as shown in this diagram will damage this charger.

PROGRAM FLOW CHART

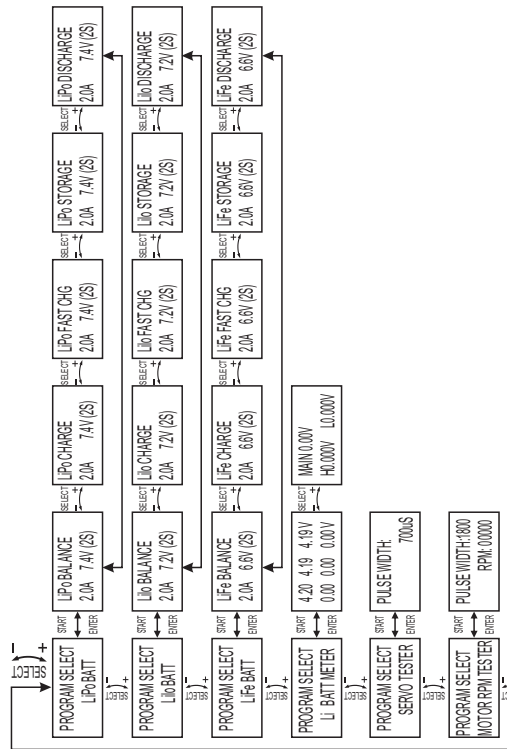

PROGRAM FLOW CHART

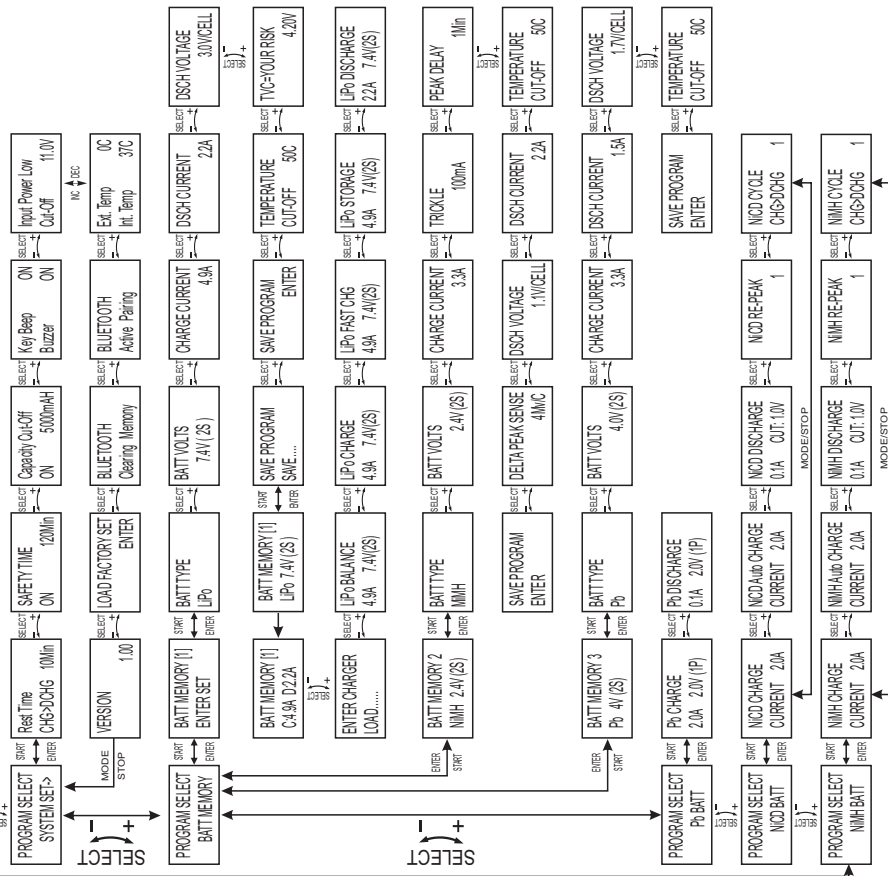

The most important tool to operate the charger is the red rotary dial and black button.



Mode/Stop Button

Enter/Start Rotary Dial

Enter/Start Rotary Dial

The dial has three functions: rotating the dial in both directions will scroll through menus and adjust parameters quickly and easily, and pressing down on the dial acts as button which is often used to enter parameter alert or store parameters on-screen.

Mode/Stop Button

It is used to stop the progress or go back to previous step/screen.

When you are willing to alter the parameter value in the program, press the dial to make it blink then change the value by rotating the dial clockwise or counterclockwise. The value will be stored by re-pressing the dial. When you are willing to start the progress, press and hold the dial for 3 seconds. When you are willing to stop the progress or go back to previous step/screen, press the button once.

When you power on the charger, it will enter LiPo Battery balance program directly. You could change the mode (balance mode, normal charge mode, fast charge mode, store mode or discharge mode), enter the desired charging/discharging mode, set the referred parameter and start the progress.

If you have no request for LiPo Battery program, please press the button to enter Program Select screen.

These programs are only suitable for charging and discharging lithium batteries with a nominal voltage of 3.7V, 3.6V and 3.3V per cell. These batteries need to adopt different charge technique which is termed as constant voltage(CV) and constant current(CC) method. The charge current varies according to the battery capacity and performance. The final voltage of charge process is also very important; it should be precisely matched with the charge voltage of the battery. They are 4.2V for LiPo, 3.6 V for LiFe, and 4.1V for Lilon. The charge current and nominal voltage as for cell count set on the charge program must always be correct for the battery to be charged.

CHARGING LITHIUM BATTERY AT BALANCE MODE

This function is for balancing the voltage of lithium-polymer battery cells while charging.

In the balance mode, the battery needs to connect to the battery's power lead with balance wire.

In this mode, the charging process will be different from ordinary charging mode. The internal processor of the charger will monitor the voltages of each cell of the battery pack and control charging current which is feeding to each cell to equalize the voltage.

Note: We recommend charging lithium batteries with a balance wire in the balance mode only.

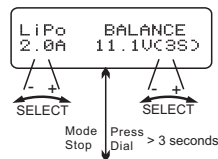

The left side of the first line shows the type of battery you choose. The value on the left of the second line of the charger is current the user sets. After setting the current and voltage, press and hold the dial for 3 seconds to start the process.

```
R: 3SER S: 3SER
CONFIRM<CENTER>
```

Press Dial

```
Li3s 1.2A 12.59V
Chg 022:43 00682
```

Number of cells | Charging current | Battery voltage | Charged capacity

This screen displays the number of cells you set up and the processor detects. R shows the number of cells detected by the charger and S is the number of cells set by you at the previous screen. If both numbers are identical you can start charging process. If not, press button to go back to previous screen to recheck the number of cells of the battery pack before going ahead.

This screen shows the real-time status during charge process. Press button once to stop the charge process.

CHARGING OF LITHIUM BATTERY

This charging mode is for charging LiPo/LiFe/LiIon battery in normal mode.

Note: We recommend charging lithium batteries with a balance lead in the balance mode only.

```
LiPo CHARGE
2.0A 11.1VCSS
```

Mode Stop | Press Dial > 3 seconds

The left side of the first line shows the type of battery you choose. The value on the left of the second line of the charger is current and voltage, press and hold the dial for 3 seconds to start the process.

```
R: 3SER S: 3SER
CONFIRM<CENTER>
```

This displays the number of cells you set up and the processor detects. R shows the number of cells detected by the charger and

Press Dial

```
Li3s 1.2A 12.59V
Chg 022:43 00682
```

Number of cells | Charging time | Battery voltage | Charged capacity

S is the number of cells set by you at the previous screen. If both numbers are identical you can start charging process. If not, press button to go back to previous screen to recheck the number of cells of the battery pack before going ahead.

This screen shows the real-time status during charge process. Press button once to stop the charge process.

'FAST' CHARGING OF LITHIUM BATTERY

The charging current is getting smaller as the process goes to the near end term of Lithium battery charging. To finish charging process earlier, this program eliminate certain period of CV process. Actually, the charging current will goes to 1/5 from the initial value to end the process while the normal charging goes to 1/10 during CV period. The charging capacity may be a bit smaller than normal charging but the process time will be reduced.

```
LiPo FAST CHG
2.0A 11.1VCSS
```

Mode Stop | Press Dial > 3 seconds

The value on the left side of the second lines shows the charge current. The value on the right side of the second lines shows the battery pack's voltage. After setting current and voltage, press and hold the dial for 3 seconds to start the process.

```
R: 3SER S: 3SER
CONFIRM<CENTER>
```

This displays the number of cells you set up and the processor detects. R shows the number of cells detected by the charger and S is the number of cells set by you at the previous screen. If both numbers are

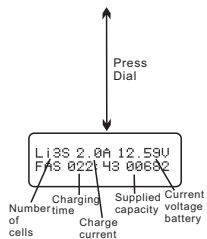

identical you can start charging process. If not, press button to go back to previous screen to recheck the number of cells of the battery pack before going ahead.

This screen shows the real-time status during charge process. Press button once to stop the charge process.

'STORAGE' CONTROL OF LITHIUM BATTERY

This program is for charging or discharging Lithium battery which will not be used for long time. The program will determine to charge or discharge the battery to certain voltage depending on the voltage of the battery at its initial stage. They are different from the type of the battery, 3.75V for Lilo, 3.85V for LiPo and 3.3V for LiFe per cell. If the voltage of battery at its initial stage is over the voltage level to storage, the program will start to discharge.

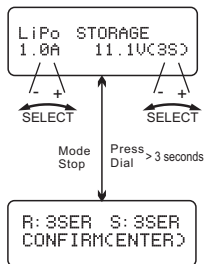

At this screen, you can set up the current and voltage of the battery pack. Charging and discharging will make the batteries come to the voltage level of storage state.

This screen displays the number of cells you set up and the processor detects. R shows the number of cells detected by the charger and S is the number of cells set by you at the previous screen. If both numbers are identical you can start charging process. If not, press Mode/Stop button to go back to

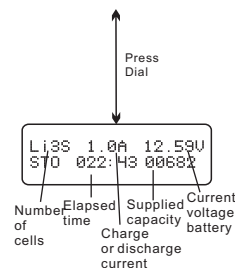

previous screen to recheck the number of cells of the battery pack before going ahead.

This screen shows the real-time status charging. Press Mode/Stop button once to stop the charge process.

DISCHARGING LITHIUM BATTERY

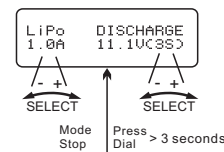

The value of discharge current on the left can not exceed 1C, and the value on the right can not be under the voltage recommended by the manufacturer to avoid over discharging. Press and hold the dial for 3 seconds to start discharging.

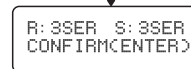

This screen displays the number of cells you set up and the processor detects. R shows the number of cells detected by the charger and S is the number of cells set by you at the previous screen. If both numbers are identical you can start charging process. If not, press Mode/Stop button to go back to previous screen to recheck the number of cells of the battery pack before going ahead.

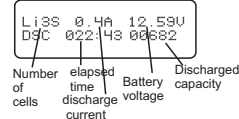

This screen shows the real-time status of discharging, you can press Mode/Stop button to stop discharging.

NIMH/NICD BATTERY PROGRAM

These programs are for charging or discharging NiMH (Nickel-Metal-Hydride) or NiCd (Nickel-Cadmium) battery.

CHARGING OF NIMH/NICD BATTERY

The charger will charge NiMH and NiCd batteries using the charge current set by the user.

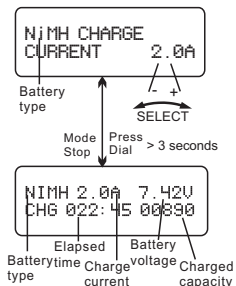

This program is for charging of NiMH/NiCd batteries. You can press Start/Enter dial to make the parameter blink, then rotate the dial to change the value and repress the dial to store the value.

The screen displays the current state of charging. To stop the process, press Mode/Stop button once.

The audible sound indicates the end of process.

CHARGING NIMH/NICD BATTERY IN THE AUTO CHARGE MODE

In this program the charger detects the condition of the battery which is connected to the output and automatically charges the battery. In this mode, you should set up the upper limit of the charge current to avoid damage by excessive feeding current. Some batteries of low resistance and capacity can lead to higher current in the auto charging mode.

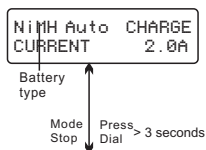

This program is for charging of NiMH/NiCd batteries in auto mode. You can press Start/Enter dial to make it blink and then rotate the dial to change the parameter value. Press START/ENTER dial to store the value.

NIMH/NICD BATTERY PROGRAM

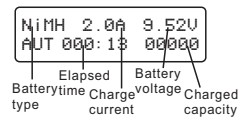

The screen displays the current state of charging.

To stop the process, press Mode/Stop button once.

The audible sound indicates the end of process.

CHARGING NIMH/NICD BATTERY IN RE-PEAK CHARGE MODE

Re-peak Charge Mode (NiMH and NiCd batteries only): In re-peak charge mode, the charger can peak charge the battery once, twice or three times in a row automatically. This is good for confirming the battery is fully charged, and for checking how well the battery receives fast charges. A five minute cool-off delay occurs after each re-peak charge. To start charge, press and hold the dial for 3 seconds.

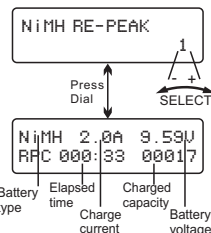

Re-peak cycle number 1 shows on the display. Press the dial to make the re-peak cycle number blink and rotate the dial to find the desired number of times to re-peak charge the battery.

Press the dial to confirm selection.

DISCHARGING OF NIMH/NICD BATTERY

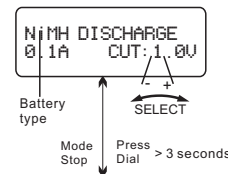

Set discharge current on the left and final voltage on the right. The discharge current ranges from 0.1 to 5.0A and the final voltage ranges from 0.1 to 25.2V. To start the process, press and hold Start /Enter dial for 3 seconds.

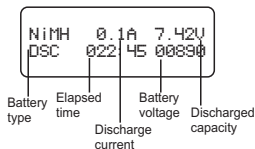

The screen indicates the discharging state. You can rotate the Start/Enter dial to alter discharge current and repress the dial to stop discharging. The audible sound indicates the end of process.

CHARGE/DISCHARGE & DISCHARGE/CHARGE CYCLE OF NIMH/NICD BATTERY

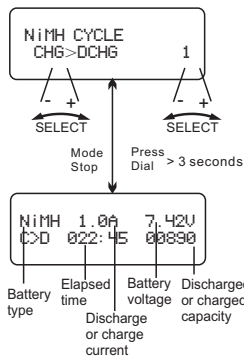

You can set up sequence on the left and the number of cycles on the right. Range of the cycle number is 1-5.

Press Mode/Stop key to stop program, you can rotate the Start/Enter dial to alter the current.

This is programmed for charging Pb (lead-sulphuric acid) battery with nominal voltage from 2 to 20V. Pb batteries are totally different from NiMH or NiCd batteries. They can only deliver relatively lower current comparing to their capacity, and similar restrictions definitely apply to charge. So the optimal charge current will be 1/10 of the capacity. Pb batteries must not be charged rapidly. Always follow the instruction supplied by the battery manufacturer.

CHARGING OF PB BATTERY

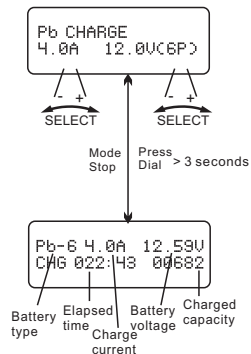

Set up the charge current on the left and the nominal voltage of the battery on the right. The charge current ranges from 0.1 to 10.0A and the voltage should be matched with the battery being charged. Start the charge process by pressing and holding the dial for 3 seconds.

The screen displays the state of charging process. To stop charging forcibly, press Mode/Stop button once. The audible sound indicates end of process.

DISCHARGING OF PB BATTERY

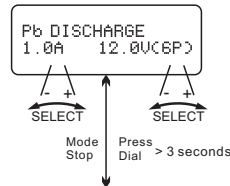

Set discharge current on the left and final voltage on the right. The discharge current ranges from 0.1 to 5.0A. To start the process, press and hold the Start/Enter dial for 3 seconds.

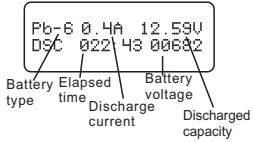

The screen displays the current state of discharge. You can alter the discharge current by pressing Start/Enter dial during the process. Once you find the desired current value by rotating the dial, store it by repressing the dial.

To stop discharging, press Mode/Stop button once. The audible sound indicates the end of process.

USING THE CHARGE CONTROL SOFTWARE "CHARGE MASTER"

The free "Charge Master" software gives you unparalleled ability to operate the charger through the computer. You can monitor pack voltage, cell voltage and other data during the charging process, view charging data in real-time graphs. And you can initiate, control charging and update firmware from "Charge Master".

In order to connect the charger to the computer and use the "Charge Master", you are required to use a USB cable which is not included in this package. The cable must be terminated on one end with "A" plug and the opposite end is terminated with "mini-B" plug which can connect to the charger directly.

The "Charge Master" can be download from www.skyrc.com. For more details, please refer to HELP file which can be found in "Charge Master" software.

The charger can store up to 10 different charge/discharge profiles for your convenience, and the stored profiles can be recalled quickly without having to go through the setup process.



Press Dial >3 seconds

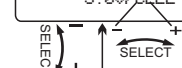
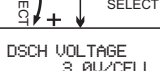
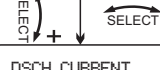
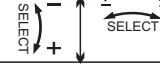
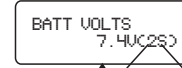
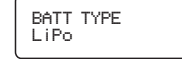

Enter the battery memory program, you can change the battery type(LiPo, LiFe, Lilon, NiMH, NiCd, Pb battery), voltage, charge current by pressing the Start/Enter dial to make the value blink, then rotate the Start/Enter dial clockwise or counterclockwise to alter the value, and repress Start/Enter dial to store the value and move to the next value or screen.

Note:The battery used for this example is a 2S(7.4V) Lipo battery.

Set the voltage and number of cells, along with the normal voltage (1S-6S).

Set the charge current, which can be adjusted(0.1-10.0A).

Set the discharge current, which can be adjusted (0.1A-5.0A).

Set the discharge voltage, which can be adjusted (3.0-3.3V/Cell).

BATTERY MEMORY SET

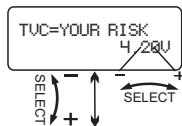

Set the terminal voltage, which can be adjusted(4.18-4.30V).

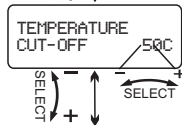

Set the cut-off temperature, which can be adjusted(20°C/68°F-80°C/176°F).

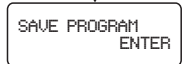

Save the program set by pressing and holding the Start/Enter dial for 3 seconds.

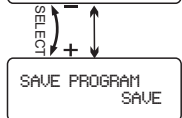

Press Dial >3 seconds

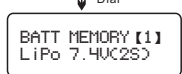

This screen indicate the saved profile.

next flash

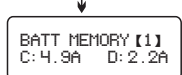

Once you've saved a charge profile, you can load those settings to use later. To load a memory, you have to press and hold the Start/Enter dial for 3 seconds. Otherwise you only enter the setting mode.

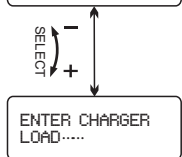

This screen indicates that the charge profile is being loaded.

LITHIUM BATTERY METER

The user can check battery's total voltage, the highest voltage, the lowest voltage and each cell's voltage.
Please connect the battery to the charger main battery lead to battery socket and balance wires to balance socket.

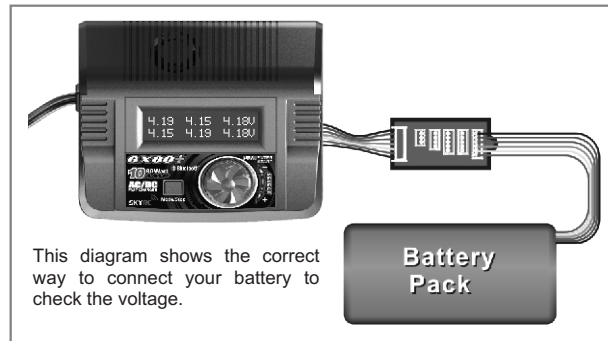

Press the Start/Enter dial to enter the Lithium Battery Meter program.

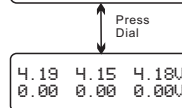

The screen indicate each cell's voltage.

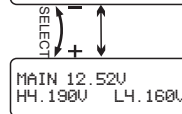

The screen indicate the total voltage, the highest voltage, the lowest voltage.

MOTOR RPM TESTER

The charger can test motor RPM. Please do as follows,

1. Connect the motor and ESC.
2. Switch off the ESC and connect it to the battery.
3. Connect the power to the charger.
4. Insert the ESC signal wire to ESC port in the charger.
5. Connect the motor and charger with motor sensor wire. There is a motor sensor port beside the temp sensor.
6. Enter Motor RPM Tester Program, set the initial pulse width which should be the same as the neutral position of the transmitter. We suggest to set it to 1480 as most of the transmitters' neutral position is like that.
7. Switch on the ESC. Change the pulse width and check the RPM corresponding to different pulse width. If the motor doesn't run, please recheck the transmitters' neutral position and reset the initial pulse width.

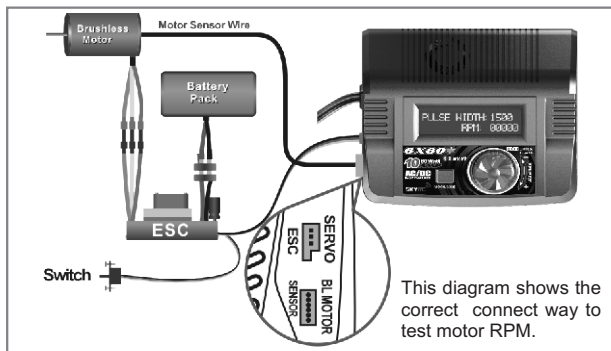

PROGRAM SELECT
MOTOR RPM TESTER

SELECT
-
+
↑
↓

PULSE WIDTH: 1500
RPM: 00000

- +
SELECT

Press the Start/Enter dial to enter the Motor RPM Tester Program and set the initial pulse width by rotating the Start/Enter knob. Switch on the ESC.

The left side of the first line shows the pulse width and the second line shows the RPM of the motor corresponding to different pulse width. The value of pulse width can be changed by rotating the Start/Enter dial.

SERVO TESTER

The charger can check whether the servo works. Please do as follows,

1. Connect the battery to the power.
2. Connect the servo to the servo port in left side of the charger. Be careful with the correct polarity.
3. Enter to Servo Tester Program in the charger, change the pulse width and check the response of the servo.

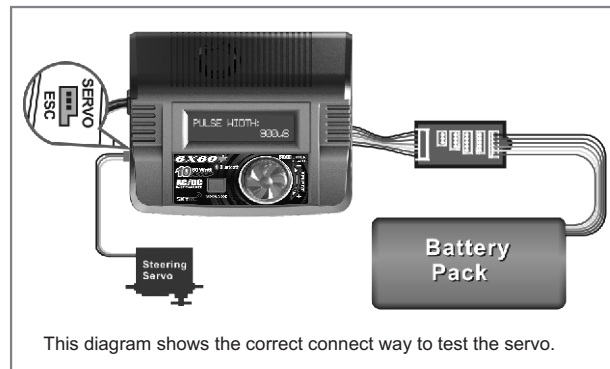

PROGRAM SELECT
SERVO TESTER

SELECT
-
+
↑
↓

PULSE WIDTH:
300us

- +
SELECT

Press the Start/Enter dial to enter the Servo Tester Program.

The screen displays the pulse width. Rotate the Start/Enter dial to change the value of pulse width and observe the response of the servo corresponding to different pulse width

It will be operated with the default value of the essential user settings when it is connected to a DC 11~18V battery for the first time. The screen displays the following information in sequence and the user can change the value of parameter on each screen.

When you are willing to alter the parameter value, press the dial to make it blink then change the value by rotating the dial clockwise or counterclockwise. The value will be stored by repressing the dial.

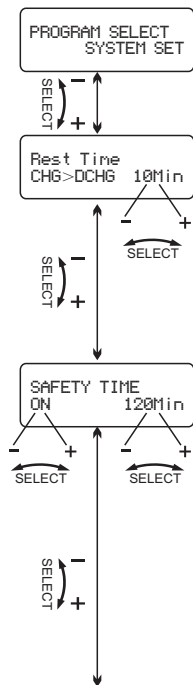

User set up starting screen.

The battery is on the cyclic process of charge and discharge can often become warm after charge or discharge period. The program can insert a time delay to occur after each charge and discharge process to allow the battery adequate time to cool down before being subjected to the next process. The value ranges from 1 to 60 minutes.

When you start a charge process, the integral safety timer automatically starts running at the same time. This is programmed to prevent overcharge the battery if it proves to be faulty, or if the termination circuit cannot detect the battery full. The value for the safety timer should be generous enough to allow a full charge of the battery.

Safe timer Calculation

When charging NiMH or NiCd batteries, divide the capacity by current, then divide the result

by 11.9, set this number as the value for safety timer setting. If the charger stopped at this threshold, about 140% of the capacity will have been fed into the battery.

For example:

Capacity	Current	Safety Time
2000mAh	2.0A	$(2000/2.0=1000)/11.9=84$ minutes
3300mAh	3.0A	$(3300/3.0=1100)/11.9=92$ minutes
1000mAh	1.2A	$(1000/1.2=833)/11.9=70$ minutes

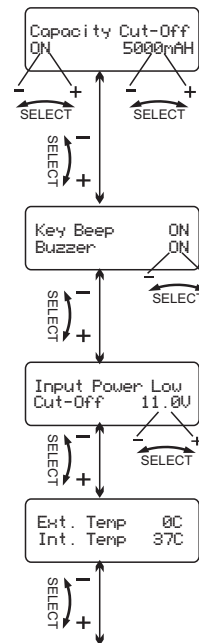

This program sets the maximum charge capacity that will be supplied to the battery during charge. If the deltapack voltage is not detected nor the safety timer expired by any reason, this feature will automatically stop the process at the selected capacity value.

The beep sounds at every time pressing the buttons to confirm your action. The beep or melody sounded at various times during operation to alert different mode changes. These audible sounds can be on or off.

This program monitors the voltage of input battery. If the voltage drops below the value you set the operation forcibly terminated to protect the input battery.

This screen shows the external and internal temperature.

LOAD FACTORY SET
ENTER



Press and hold the Start/Enter dial for 3 seconds to load the factory set.

VERSION 1.00

This screen shows the version.

VARIOUS INFORMATION DURING THE PROCESS

You can inquire various information on LCD screen during charging or discharging process. When you rotate the dial counterclockwise, the screen will display the user's settings.

And also you can monitor the voltage of individual cell by rotating the dial clockwise when the individual connection cable is linked to the Lithium battery being processed.

End Voltage
12.6V<BS>

It comes to the final voltage when the program ended.

IN Power Voltage
12.56V

Present input voltage.

Ext. Temp 0C
Int. Temp 26C

This screen shows the internal temperature.

Safety Time
ON 200min

Displayed safety timer is turn on and duration of time in minutes.

Capacity Cut-Off
ON 5000mAh

Displayed capacity cut-off function is turn on and the setting value of capacity.

4.19 4.15 4.18V
0.00 0.00 0.00V

The battery is connected with balance lead, you can check voltage of each cell in the battery pack.

It incorporates a variety of functions for the systems to verify processes and the state of the electronics. In case of an error the screen will display the cause of error and emit an audible sound.

REVERSE POLARITY

Incorrect polarity connected.

CONNECTION BREAK

The battery is interrupted.

CONNECT ERROR
CHECK MAIN PORT

The Battery connection is wrong.

BALANCE CONNECT
ERROR

The balance connect is wrong.

DC IN TOO LOW

Input voltage less than 11V.

DC IN TOO HIGH

Input voltage higher than 18V.

CELL ERROR
LOW VOLTAGE

Voltage of one cell in the battery pack is too low.

CELL ERROR
HIGH VOLTAGE

Voltage of one cell in the battery pack is too high.

CELL ERROR
VOLTAGE-INVALID

Voltage of one cell in the battery pack is invalid.

CELL NUMBER
INCORRECT

The cell number is wrong.

INT. TEMP. TOO HI

The internal temperature of the unit goes too high.

EXT. TEMP. TOO HI

The external temperature of the unit goes too high.

OVER CHARGE
CAPACITY LIMIT

The battery capacity is more than the maximum capacity which the user sets.

OVER TIME LIMIT

The charging time is longer than the maximum charging time which the user sets.

BATTERY HAS FULL

The battery voltage is higher than the maximum voltage which the user sets when charging in balance mode.

Pairing occurs when two Bluetooth devices communicate with each other and establish a connection. A record of information about this connection is then stored in the memory of each device. Once you pair a device with the 6X80 charger, you should not have to pair it again.

The 6X80 charger can pair with up to eight devices. However, it can only connect to, and control the 6X80 charger from one device at a time.

To begin pairing with your iPhone, iPod or iPad

1. With 6X80 Charger is turned on, under BLUETOOTH MENU and press "Rotary Enter Button" to active Bluetooth pairing and make the charger discoverable. The Bluetooth indicator on the charger is blinking in blue to show the charger is discoverable.



2. Select the Bluetooth menu from your iPhone or iPod and ensure the Bluetooth is turned on.
3. Find the 6X80 Charger which will be identified as "SkyRC + 4 digits serial number". For example, SkyRC1234 and select it.
4. Confirm that you want to connect the 6X80 Charger with your iPhone or iPod by selecting it.
5. A confirmation "Connected" appears on your phone after you have selected the 6X80 Charger. It takes few seconds to finalize the pairing process, please wait for while.
6. The Bluetooth indicator, located on the right side of charger remains steadily on.
7. Your 6X80 Charger is now connected with your iPhone or iPod.

On your Android device:

1. With 6X80 Charger is turned on, under BLUETOOTH MENU and press "Rotary Enter Button" to active Bluetooth pairing and make the charger discoverable. The Bluetooth indicator on the charger blinking to show the charger is discoverable.



2. When the ChargeMaster starts in Android, bluetooth will be enabled and paired automatically.

Useful notes and tips

You can only connect your 6X80 Plus with one device at a time.

The Charger can hold up eight paired devices. When the memory is full and additional device cannot be paired. If you want to pair new devices, you need clearing all the memory.

Clearing memory

To clear the Charger memory of all devices, select "Clearing Memoery" from BLUETOOTH menu and press Rotary button once. The charger clears all devices from its memory and "No Memory" will display on the screen.

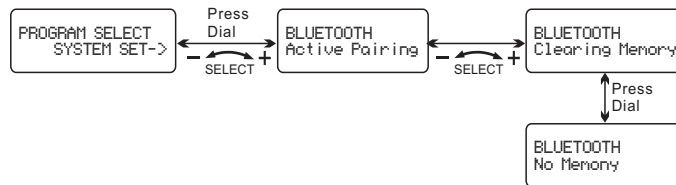

SPECIFICATION

AC Input	100-240V
DC Input	11-18Volt
Charge circuit power	AC Input 50W DC Input 80W
Charge current range	0.1-10.0A
Discharge current power	8W
Discharge current range	0.1-5.0A
Current drain for balancing port	200mA/cell
NiCd/NiMH battery cell count	1-15Cells
LiPo/LiFe/Lilon cell count	1-6Cells
Pb battery voltage	2-20V
Net weight	525g
Dimension	135x112x60.9mm

(stated values refer to one charger except built-in power supply, dimension & weight)

THE SET CONTAINS

1. SKYRC 6x80 Plus Charger
2. 18AWG Wire Charging Cable
3. Power Cord
4. Multiple Balancing Board



Temp. Sensor Cable
SK-600005-01

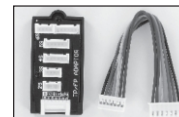

TP/FP Adaptor
SK-600018-02



HP/PQ Adaptor
SK-600016-03



EH Adaptor
SK-600014-01



XH Adaptor
SK-600020-04



Tamiya charging cable
5201-0030-01



JST/BEC charging cable
5201-0043-01



Dean charging cable
5201-0012-01



Futaba RX charging cable
5201-0044-01



TRAXXAS charging cable
5201-0033-01



Glow charging cable
5201-0045-01



Crocodile clip charging cable
5201-0031-01



EC3 charging cable
5201-0034-01

This charger is designed and approved exclusively for use with the types of battery stated in these Instruction Manual. SKYRC accepts no liability of any kind if the charger is used for any purpose other than that stated. We are unable to ensure that you follow the instructions supplied with the charger, and we have no control over the methods you employ for using, operating and maintaining the device. For this reason we are obliged to deny all liability for loss, damage or costs which are incurred due to the incompetent or incorrect use and operation of our products, or which are connected with such operation in any way. Unless otherwise prescribed by law, our obligation to pay compensation, regardless of the legal argument employed, is limited to the invoice value of those SKYRC products which were immediately and directly involved in the event in which the damage occurred.

CONFORMITY DECLARATION

SKYRC 6x80 Plus satisfies all relevant and mandatory CE directives and FCC SubPart C Intentional Radiators section 15.247

The product has been tested to meet the following technical standards:

	Test Standards	Title	Result
CE-LVD	EN60335-2-29	For safety of household and similar electrical appliances	Conform
CE-R&TTE	EN 300328	Wideband transmission systems; Data transmission equipment operating in the 2,4 GHz ISM band and using wide band modulation techniques article 3.1(b) EMC requirements	Conform
	EN 301489-1	Electromagnetic compatibility and Radio spectrum Matters (ERM); ElectroMagnetic Compatibility (EMC) standard for radio equipment and services. Part 1: Common technical requirements	Conform
	EN 301489-17	Electromagnetic compatibility and Radio spectrum Matters (ERM); ElectroMagnetic Compatibility (EMC) standard for radio equipment and services. Part 17: Specific conditions for Broadband Data Transmission Systems article 3.1(a) Health requirements	Conform
	EN 62479	Assessment of the compliance of low power electronic and electrical equipment with the basic restrictions related to human exposure to electromagnetic fields (10 MHz to 300 GHz) article 3.1(a) Safety	Conform
FCC	FCC SubPart C Intentional Radiators section 15.247	Operation within the bands 902 - 928 MHz, 2400 - 2483.5 MHz, and 5725 - 5850 MHz.	Conform

FCC Note

This device complies with Part 15 of the FCC Rules. Operation is subject to the following two conditions: (1) this device may not cause harmful interference, and (2) this device must accept any interference received, including interference that may cause undesired operation.

The manufacturer is not responsible for any radio or tv interference caused by unauthorized modifications to this equipment. such modifications could void the user's authority to operate the equipment.

To maintain compliance with FCC's RF exposure guidelines, this equipment should be installed and operated with a minimum distance of 20cm between the radiator and your body.

This equipment has been tested and found to comply with the limits for a Class B digital device, pursuant to part 15 of the FCC Rules. These limits are designed to provide reasonable protection against harmful interference in a residential installation. This equipment generates, uses and can radiate radio frequency energy and, if not installed and used in accordance with the instructions, may cause harmful interference to radio communications. However, there is no guarantee that interference will not occur in a particular installation. If this equipment does cause harmful interference to radio or television reception, which can be determined by turning the equipment off and on, the user is encouraged to try to correct the interference by one or more of the following measures:

- Reorient or relocate the receiving antenna.
- Increase the separation between the equipment and receiver.
- Connect the equipment into an outlet on a circuit different from that to which the receiver is connected.
- Consult the dealer or an experienced radio/TV technician for help.



This symbol means that you must dispose of electrical devices from the General household waste when it reaches the end of its useful life. Take your charger to your local waste collection point or recycling centre. This applies to all countries of the European Union, and to other European countries with a separate waste collection system.

WARRANTY AND SERVICE

We guarantee this product to be free of manufacturing and assembly defects for a period of one year from the time of purchase. The warranty only applies to material or operational defects, which are present at the time of purchase. During that period, we will repair or replace free of service charge for products deemed defective due to those causes.

You will be required to produce proof of purchase (invoice or receipt). This warranty is not valid for any damage or subsequent damage arising as a result of misuse, modification or as a result of failure to observe the procedures outlined in this manual.

FINALLY, YOUR CHARGER GETS ITS OWN APP!



Scan with
your **iPhone**
to download.



Scan with
your **Android**
to download.